

Captain Beds Assembly Instructions

Important: Read All Instruction Before Assembling. Please Save Instruction For Future Use

The Instructions Are For The Following:

Page 2

22-89-XX

9 Drawer Captain Bed

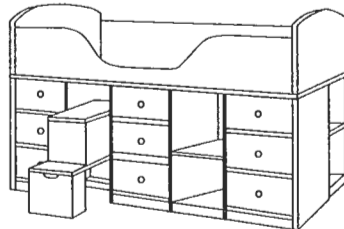

Page3

22-90-XX

Captain Bed For Two

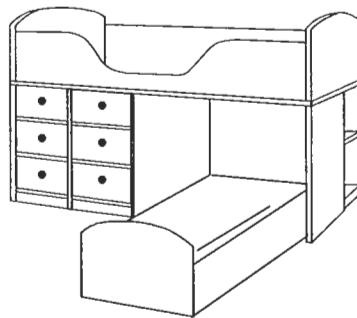

Page 4

22-91-XX

Captain Bed with Pullout Desk

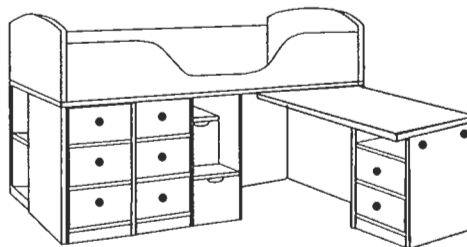

WARNING !

- * PACKAGING MATERIAL, SMALL PARTS & PLASTIC BAGS ARE HAZARDOUS TO SMALL CHILDREN. PLEASE DISPOSE OF IT IMMEDIATELY!
- * IF YOU ARE MISSING HARDWARE OR HAVE ANY QUESTIONS PLEASE CONTACT YOUR DEALER. DO NOT SUBSTITUTE PARTS! WE WILL GLADLY SEND YOU ANY HARDWARE YOU REQUIRE AT NO CHARGE.

HARDWARE INCLUDES:

1)  1/2" LONG WOOD SCREWS

3) 
PLASTIC LEVELERS

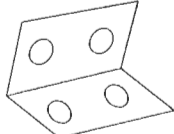
2)  L-SHAPE BRACKETS
(SIZE OF BRACKETS MAY VARY)

RECOMMENDED TOOLS:

ELECTRIC SCREWDRIVER
(WITH PHILIPS HEAD BIT)

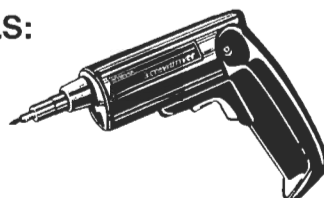

22-89-XX

9 Drawer Captain Bed

PLEASE READ ALL INSTRUCTIONS FIRST.

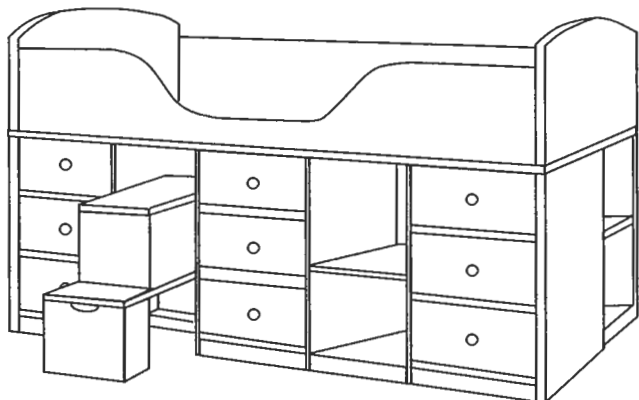

MAIN DIAGRAM

- 1. HARDWARE BAG WILL INCLUDE:**
- 1) 36 1/2" LONG WOOD SCREWS
 - 2) 6 PLASTIC LEVELERS
 - 3) 4 L-SHAPED BRACKETS (These brackets will be used to attach Headboard & Footboard of top bed assembly See Diagram C)

2. CLEAR YOUR CHOSEN LOCATION IN THE ROOM AND PLACE BACK UNIT THIS IS THE BACK PART OF THE CAPTAINS BED. IF YOU HAVE A CARPET ON THE FLOOR, MAKE YOUR FINAL DECISION OF YOUR CHOSEN LOCATION AT THIS TIME. (IT WILL BE HARD TO SHIFT THE CAPTAINS BED FROM SIDE TO SIDE ONCE IT IS ASSEMBLED).

3. PULL OUT THE DRAWERS AND THE STEPS FROM LEFT UNIT, BRING IT CLOSE TO THE LEFT SIDE OF BACK UNIT. (Pulling out drawers will allow you access to the brackets behind it)

4. PULL OUT THE DRAWERS OF RIGHT UNIT AND BRING IT CLOSE TO THE RIGHT SIDE OF BACK UNIT. SET THE DRAWERS ASIDE OUT OF YOUR WAY.

5. LEVEL THE 3 UNITS SO THE TOPS WILL CREATE ONE FLAT PLATFORM. (USE THE PLASTIC LEVELERS)

LEFT UNIT

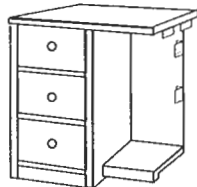

BACK UNIT

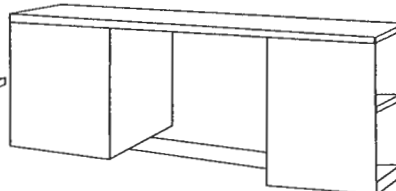

RIGHT UNIT



DIAGRAM A

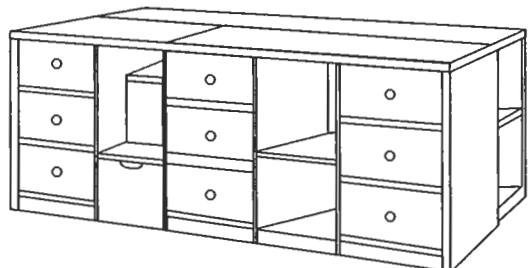

NOTE: AT THIS POINT IF YOU MUST MOVE THE BED A COUPLE OF INCHES USE HELP OF ANOTHER PERSON. SLIDE IT CAREFULLY IF BED IS SITTING ON A CARPET USE CAUTION.

6. ATTACH ALL 3 UNITS TOGETHER USING THE SCREWS AND THE L SHAPED BRACKETS. (BRACKETS ATTACHED ALREADY TO THE UNITS) USE TWO SCREWS FOR EACH BRACKET.

ATTACHMENT SHOULD BE DONE AS FOLLOWS:

A. CONNECT LEFT UNIT TO RIGHT UNIT BY USING THE 4 L SHAPE BRACKETS ATTACHED TO LEFT UNIT. NOTE THE TOP OF LEFT UNIT WILL OVERLAP RIGHT UNIT. DO NOT OVER TIGHTEN THE SCREWS.

B. CONNECT LEFT & RIGHT UNITS TO BACK UNIT. INSERT TWO SCREWS TO EACH BRACKET. SIX BRACKETS ARE LOCATED BEHIND THE DRAWERS. (SEE DIAGRAM A)

7. PUT ALL DRAWERS BACK TO THERE PLACE IN THE SAME ORDER YOU PULLED THEM OUT. SLIDE THE STEPS TO THE PLACE (SEE MAIN DIAGRAM)

8. SET UP THE BED FRAME ON THE FLOOR. HEADBOARD & FOOTBOARD WILL BE CONNECTED TO THE FRONT AND BACK RAILS BY HOOK-IN CONNECTORS.

9. LIFT THE BED (HOLDING FOOTBOARD & HEADBOARD) AND NEST IT ON TOP OF THE PLATFORM.

10. ATTACHED THE BED TO THE PLATFORM USING 2 SCREWS WITH EACH BRACKET. MAKE SURE IT IS FLUSHED ON BOTH SIDES. (SEE DIAGRAM B & C)

CONNECT 2 ADDITIONAL BRACKETS TO EACH HEADBOARD/FOOTBOARD. (SEE DIAGRAM C)

YOUR MATTRESS WILL REST DIRECTLY ON THE PLATFORM. THIS BED DOES NOT REQUIRE A BOX SPRING OR BUNKIE BOARD.

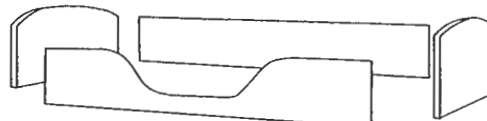

DIAGRAM B

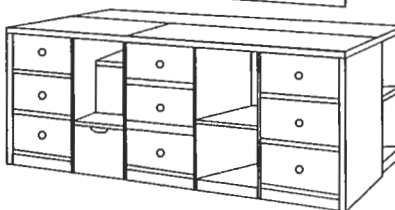
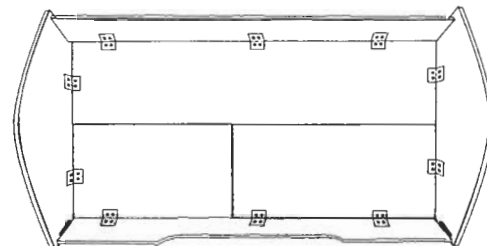
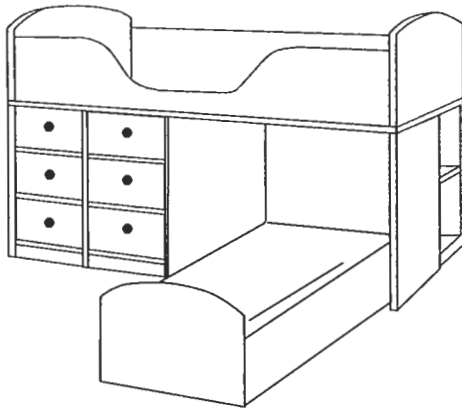

DIAGRAM C



22-90-XX
Captain Bed For Two

PLEASE READ ALL INSTRUCTIONS FIRST.



MAIN DIAGRAM

- 1. HARDWARE BAG WILL INCLUDE:**
- 1) 28 1/2" LONG WOOD SCREWS
 - 2) 6 PLASTIC LEVELERS
 - 3) 4 L-SHAPED BRACKETS (These brackets will be used to attach Headboard & Footboard of top bed assembly See Diagram C)

2. CLEAR YOUR CHOSEN LOCATION IN THE ROOM AND PLACE THE BACK UNIT. THIS IS THE BACK PART OF THE CAPTAINS BED. IF YOU HAVE A CARPET ON THE FLOOR, MAKE YOUR FINAL DECISION OF YOUR CHOSEN LOCATION AT THIS TIME. (IT WILL BE HARD TO SHIFT THE CAPTAIN BED FROM SIDE TO SIDE ONCE IT IS ASSEMBLED).

NOTE: AT THIS POINT SLIDE BOTTOM BED ASIDE TO BE PLACED LATER.

3. PULL OUT THE DRAWERS FROM LEFT UNIT, BRING IT CLOSE TO THE LEFT SIDE OF BACK UNIT.
(Pulling out drawers will allow you access to the brackets behind it)

4. BRING RIGHT UNIT CLOSE TO THE RIGHT SIDE OF BACK UNIT.

5. LEVEL THE 3 UNITS SO THE TOPS WILL CREATE ONE FLAT PLATFORM. (USE THE PLASTIC LEVELERS)

DIAGRAM A

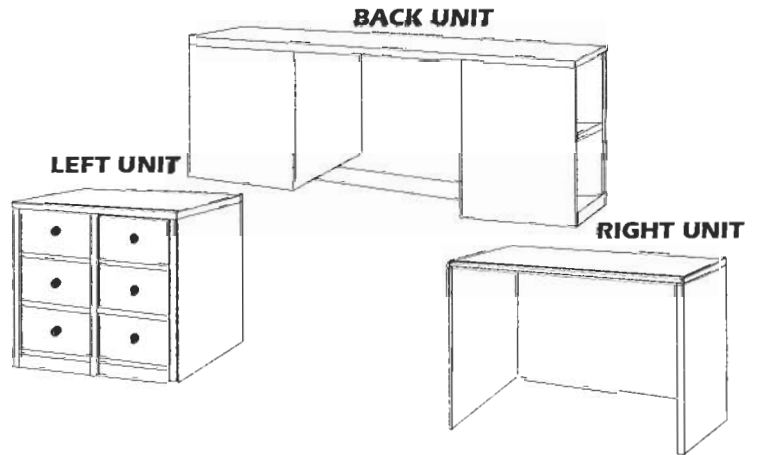
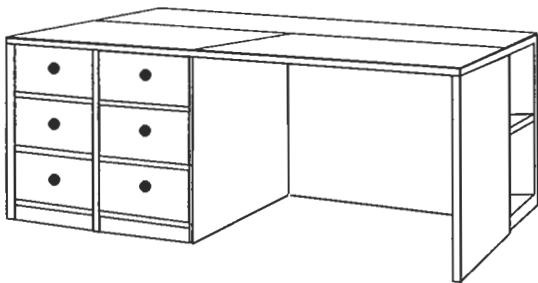

6. CONNECT LEFT UNIT TO BACK UNIT BY USING THE 8 L SHAPE BRACKETS ATTACHED TO LEFT UNIT. (SEE DIAGRAM A)

NOTE: AT THIS POINT THE RIGHT UNIT IS FREE STANDING AND WILL BE CONNECTED TO THE OTHER UNITS BY THE BED FRAME.

7. PUT ALL DRAWERS BACK TO THERE PLACE IN THE SAME ORDER YOU PULLED THEM OUT. (SEE MAIN DIAGRAM)

NOTE: AT THIS POINT IF YOU MUST MOVE THE BED A COUPLE OF INCHES USE HELP OF ANOTHER PERSON. SLIDE IT CAREFULLY IF BED IS SITTING ON A CARPET USE CAUTION.

8. SET UP THE BED FRAME ON THE FLOOR. HEADBOARD & FOOTBOARD WILL BE CONNECTED TO THE FRONT AND BACK RAILS BY HOOK-IN CONNECTORS.

9. LIFT THE BED (HOLDING FOOTBOARD & HEADBOARD) AND NEST IT ON TOP OF THE PLATFORM. (SEE DIAGRAM B)

10. ATTACHED THE BED TO THE PLATFORM USING 2 SCREWS WITH EACH BRACKET. MAKE SURE IT IS FLUSHED ON BOTH SIDES. (SEE DIAGRAM B & C)

CONNECT 2 ADDITIONAL BRACKETS TO EACH HEADBOARD & FOOTBOARD. (SEE DIAGRAM C)

YOUR MATTRESS WILL REST DIRECTLY ON THE PLATFORM. THIS BED DOES NOT REQUIRE A BOX SPRING OR BUNKIE BOARD.

11. SLIDE BOTTOM BED INTO IT'S PLACE (SEE MAIN DIAGRAM)

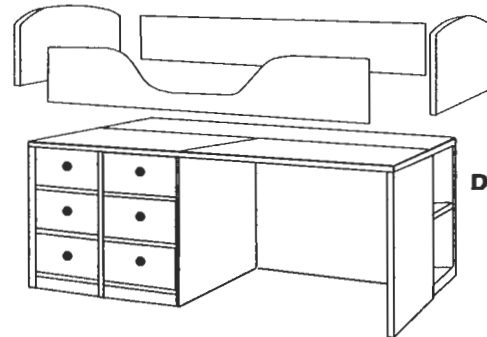

DIAGRAM B

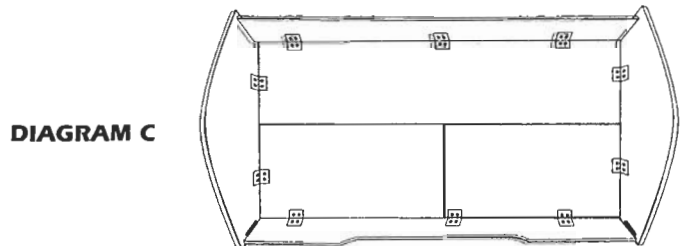
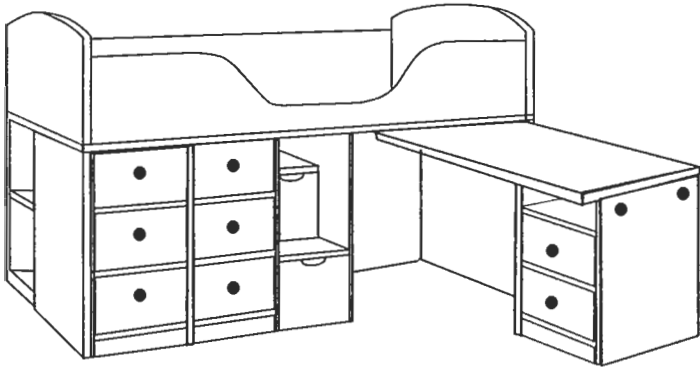

DIAGRAM C

22-91-XX

Captain Bed With Pullout Desk

PLEASE READ ALL INSTRUCTIONS FIRST.



MAIN DIAGRAM

1. HARDWARE BAG WILL INCLUDE:

- 1) 28 1/2" LONG WOOD SCREWS
- 2) 6 PLASTIC LEVELERS
- 3) 4 L-SHAPED BRACKETS (These brackets will be used to attach Headboard & Footboard of top bed assembly See Diagram C)

2. CLEAR YOUR CHOSEN LOCATION IN THE ROOM AND PLACE THE BACK UNIT. THIS IS THE BACK PART OF THE CAPTAINS BED. IF YOU HAVE A CARPET ON THE FLOOR, MAKE YOUR FINAL DECISION OF YOUR CHOSEN LOCATION AT THIS TIME. (IT WILL BE HARD TO SHIFT THE CAPTAIN BED FROM SIDE TO SIDE ONCE IT IS ASSEMBLED).

NOTE: AT THIS POINT SLIDE PULLOUT DESK ASIDE TO BE PLACED LATER.

3. PULL OUT THE DRAWERS FROM LEFT UNIT, BRING IT CLOSE TO THE LEFT SIDE OF BACK UNIT.

(Pulling out drawers will allow you access to the brackets behind it)

4. BRING RIGHT UNIT CLOSE TO THE RIGHT SIDE OF BACK UNIT.

5. LEVEL THE 3 UNITS SO THE TOPS WILL CREATE ONE FLAT PLATFORM. (USE THE PLASTIC LEVELERS)

DIAGRAM A

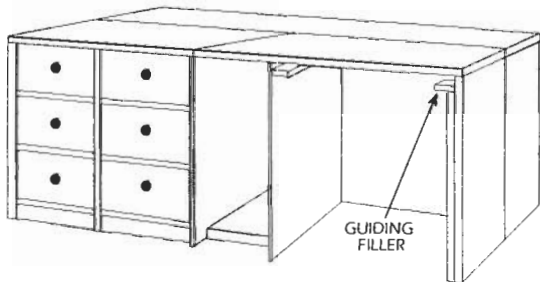

NOTE: AT THIS POINT IF YOU MUST MOVE THE BED A COUPLE OF INCHES USE HELP OF ANOTHER PERSON. SLIDE IT CAREFULLY IF BED IS SITTING ON A CARPET USE CAUTION.

8. SET UP THE BED FRAME ON THE FLOOR. HEADBOARD & FOOTBOARD WILL BE CONNECTED TO THE FRONT AND BACK RAILS BY HOOK-IN CONNECTORS.

9. LIFT THE BED (HOLDING FOOTBOARD & HEADBOARD) AND NEST IT ON TOP OF THE PLATFORM. (SEE DIAGRAM B)

10. ATTACHED THE BED TO THE PLATFORM USING 2 SCREWS WITH EACH BRACKET. MAKE SURE IT IS FLUSHED ON BOTH SIDES. (SEE DIAGRAM B & C)

CONNECT 2 ADDITIONAL BRACKETS TO EACH HEADBOARD & FOOTBOARD. (SEE DIAGRAM C)

YOUR MATTRESS WILL REST DIRECTLY ON THE PLATFORM. THIS BED DOES NOT REQUIRE A BOX SPRING OR BUNKIE BOARD.

11. SLIDE PULLOUT DESK INTO IT'S PLACE (SEE MAIN DIAGRAM)
NOTE: INSERT RIGHT CORNER OF THE DESKTOP FIRST. SO THE STOPPER BRACKET IS BEYOND THE GUIDING FILLER (SEE DIAGRAM A)

BACK UNIT

LEFT UNIT

RIGHT UNIT

6. CONNECT LEFT UNIT TO BACK UNIT BY USING THE 8 L SHAPE BRACKETS ATTACHED TO LEFT UNIT. (SEE DIAGRAM A)

NOTE: AT THIS POINT THE **RIGHT UNIT** IS FREE STANDING AND WILL BE CONNECTED TO THE OTHER UNITS BY THE BED FRAME.

7. PUT ALL DRAWERS BACK TO THERE PLACE IN THE SAME ORDER YOU PULLED THEM OUT. (SEE MAIN DIAGRAM)

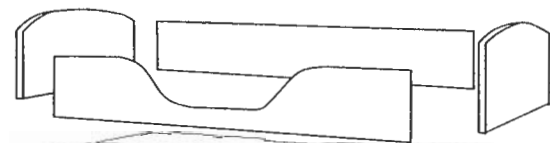

DIAGRAM B

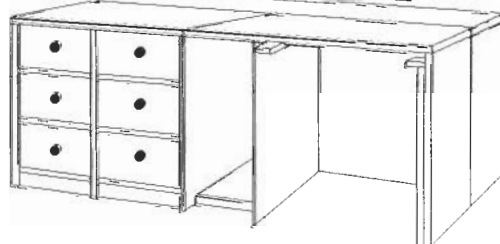

DIAGRAM C

